

**GAMBAR PERENCANAAN
PENGENDALIAN BANJIR SUNGAI TOR**

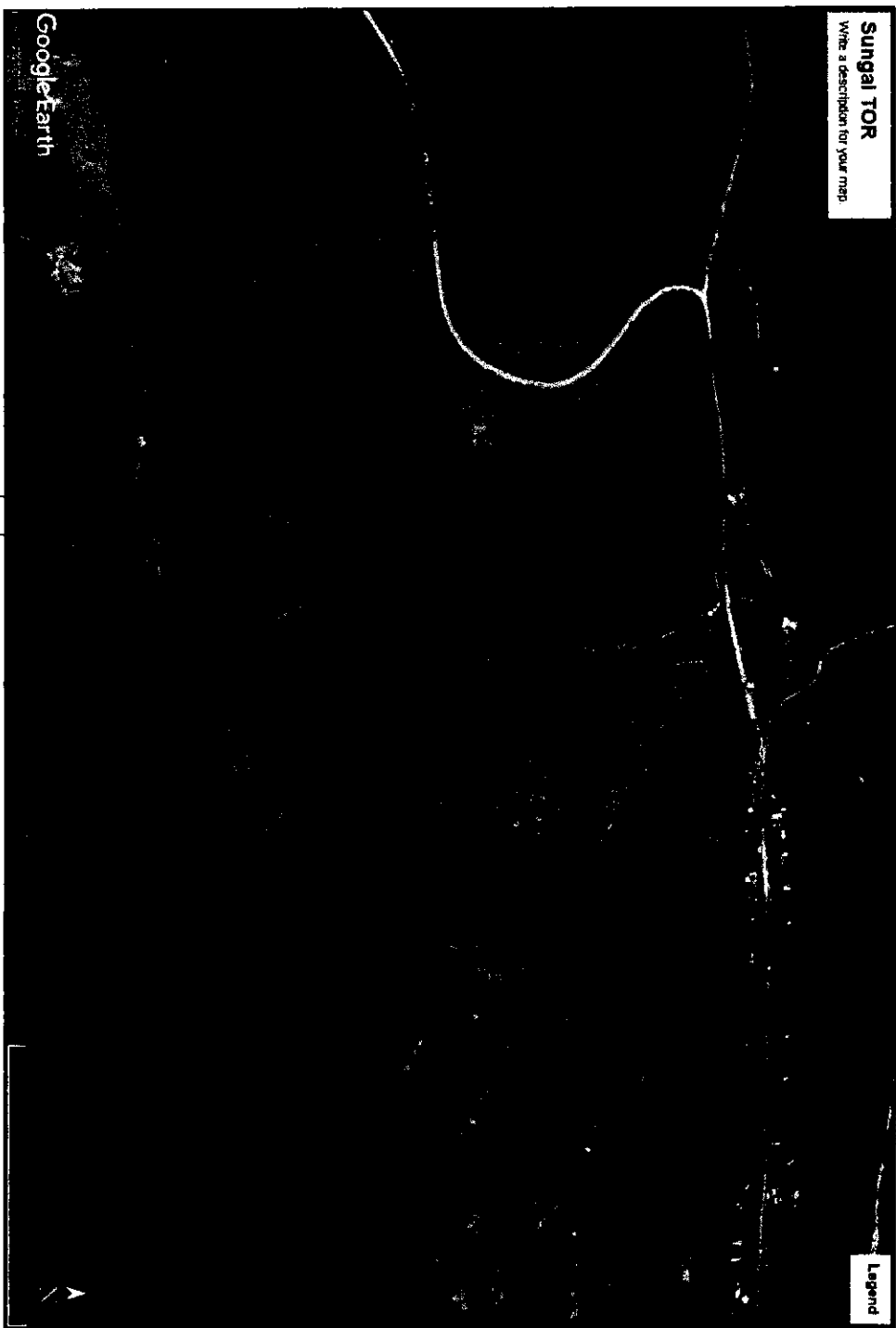

Sungai TOR
Write a description for your map



Google Earth

Legend

RENCANA NORMALISASI SUNGAI
700 Meter

RENCANA SHEET PILE BETON
150 Meter

RENCANA BRONJONG
150 Meter

JUDUL GAMBAR	SKALA
PETA LOKASI PEKERJAAN	Not Scale
LEMBAR	01

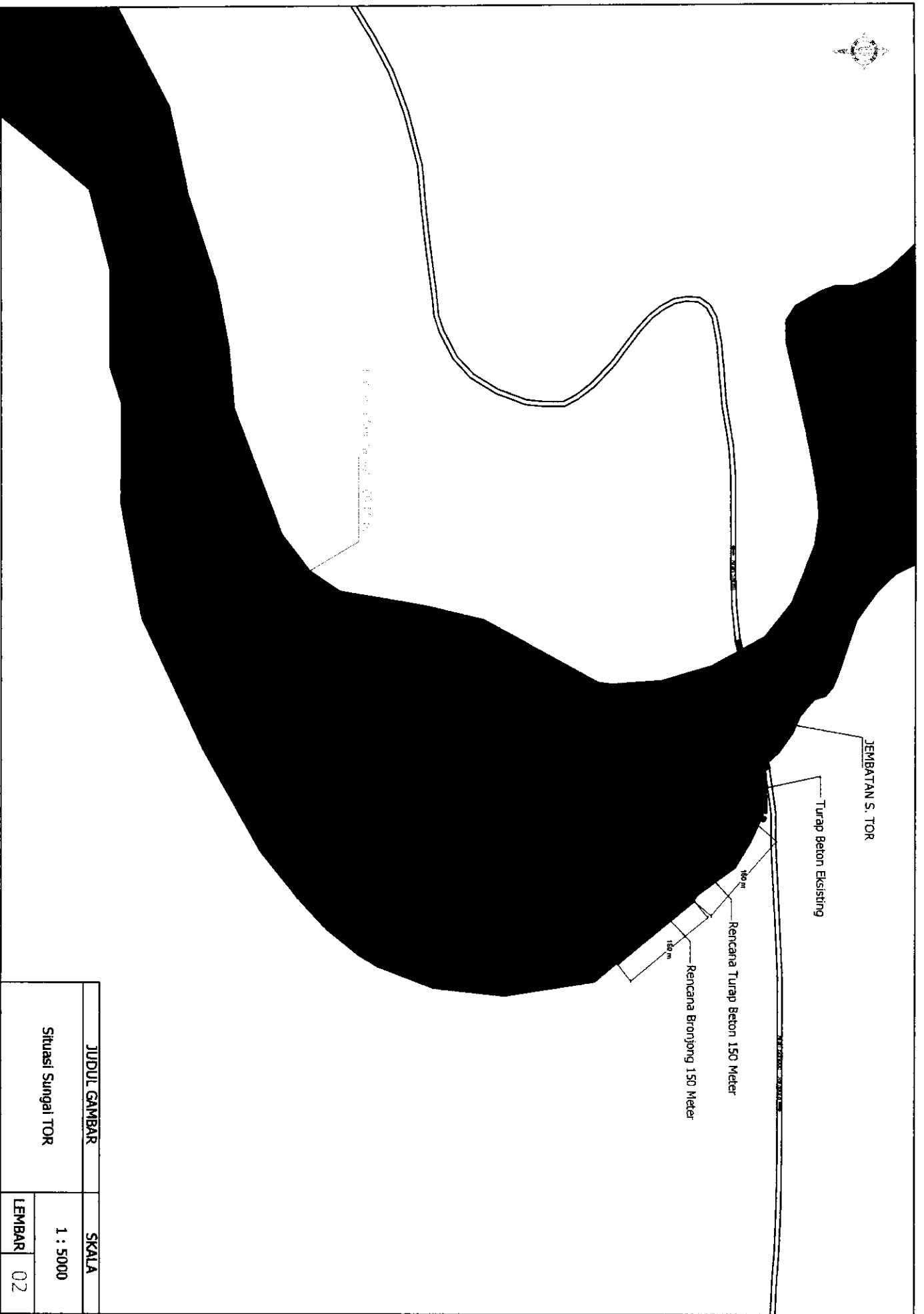

JUDUL GAMBAR		SKALA
Situasi Sungai TOR		1 : 5000
LEMBAR	02	



JEMBATAN S. TOR

Turap Beton Eksisting

SUNGAI TOR

Pemukiman Warga

Pemukiman Warga

150 m

Rencana Turap Beton 150 Meter

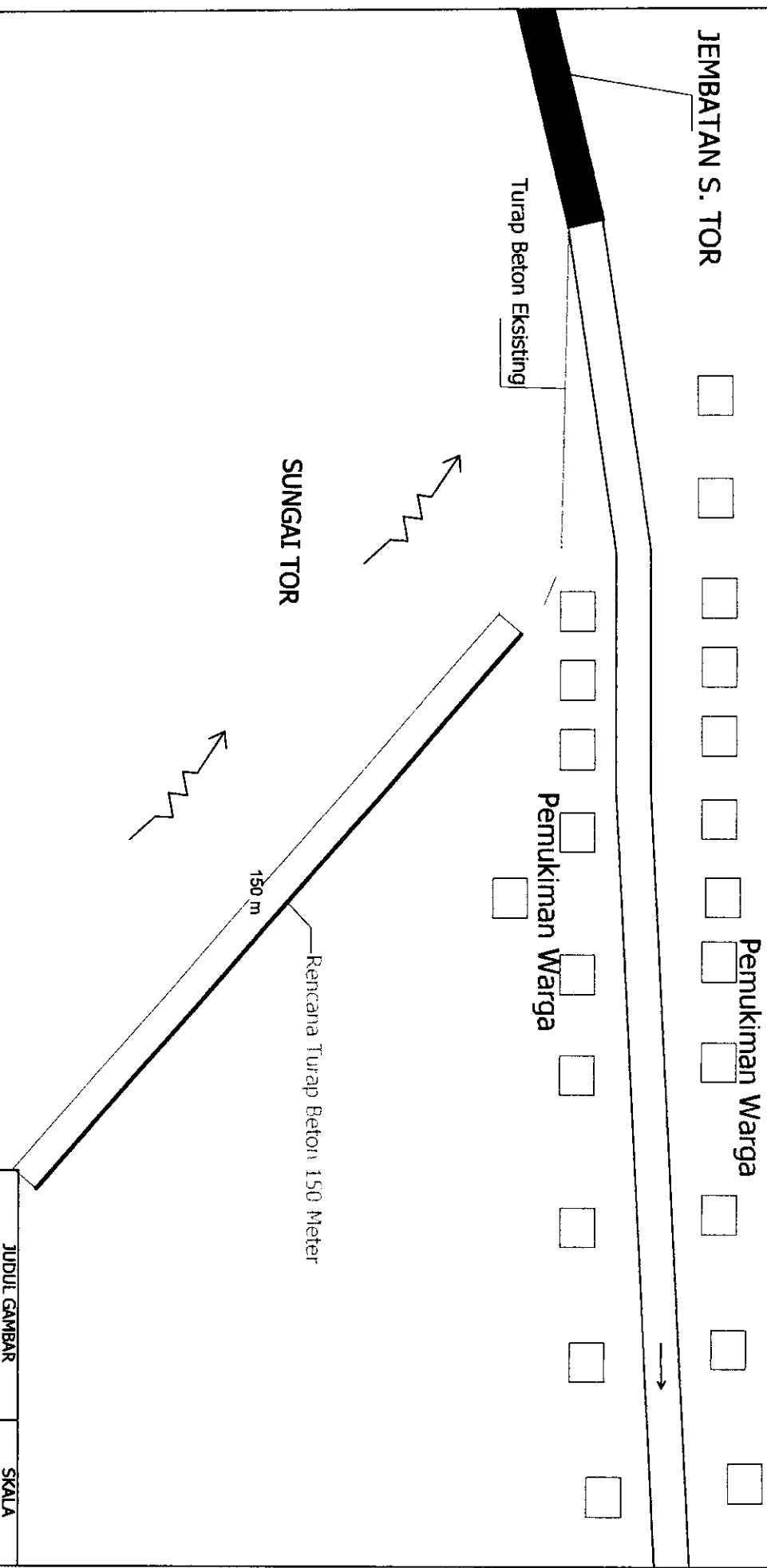

JUDUL GAMBAR

Denah Sheet Pile Beton

SKALA

1 : 800

LEMBAR 03

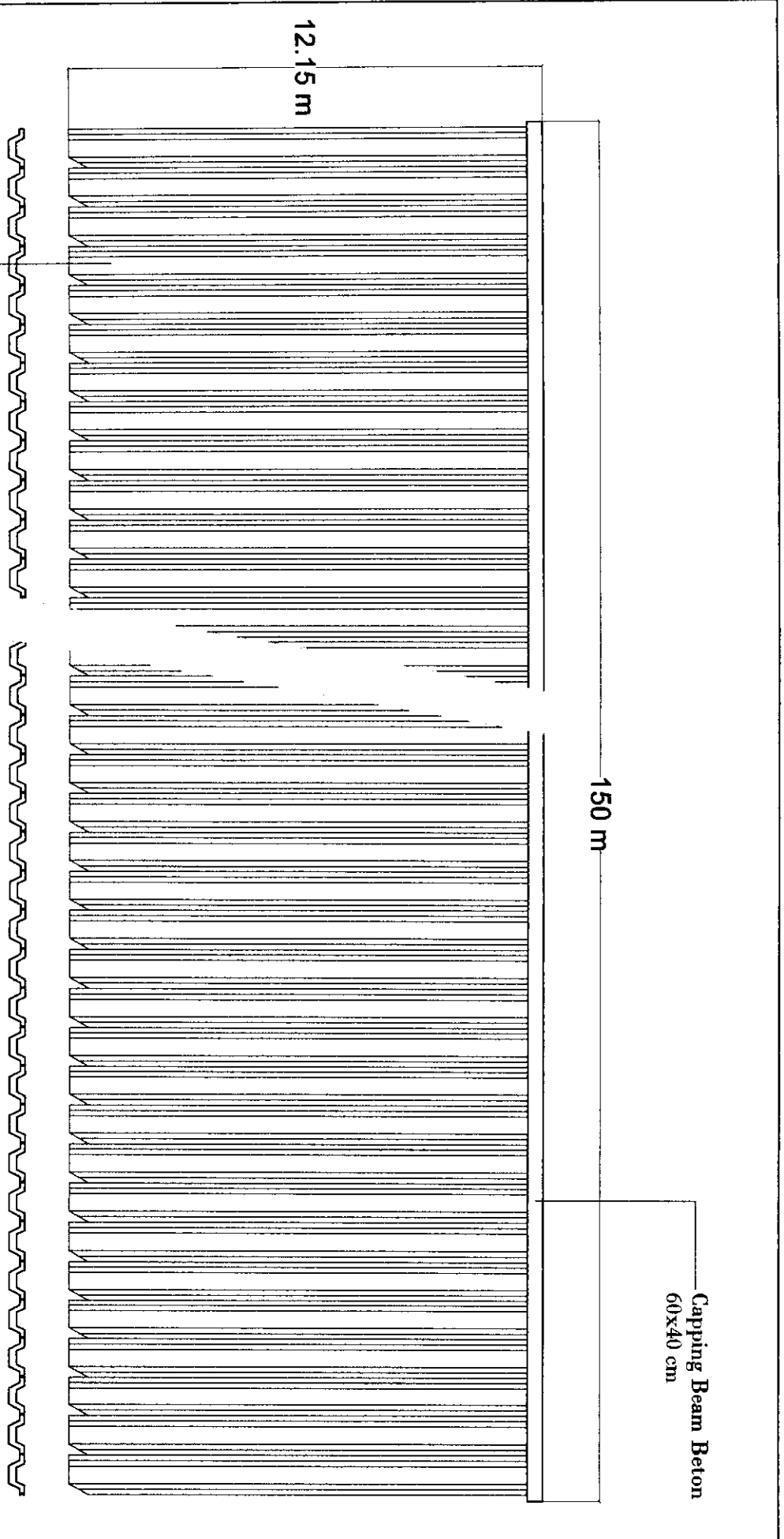

Capping Beam Beton
60x40 cm

150 m

12.15 m

Sheet Pile Beton W-400x120x200

JUDUL GAMBAR		SKALA
Tampak Depan Sheet Pile		1 : 100
LEMBAR	04	

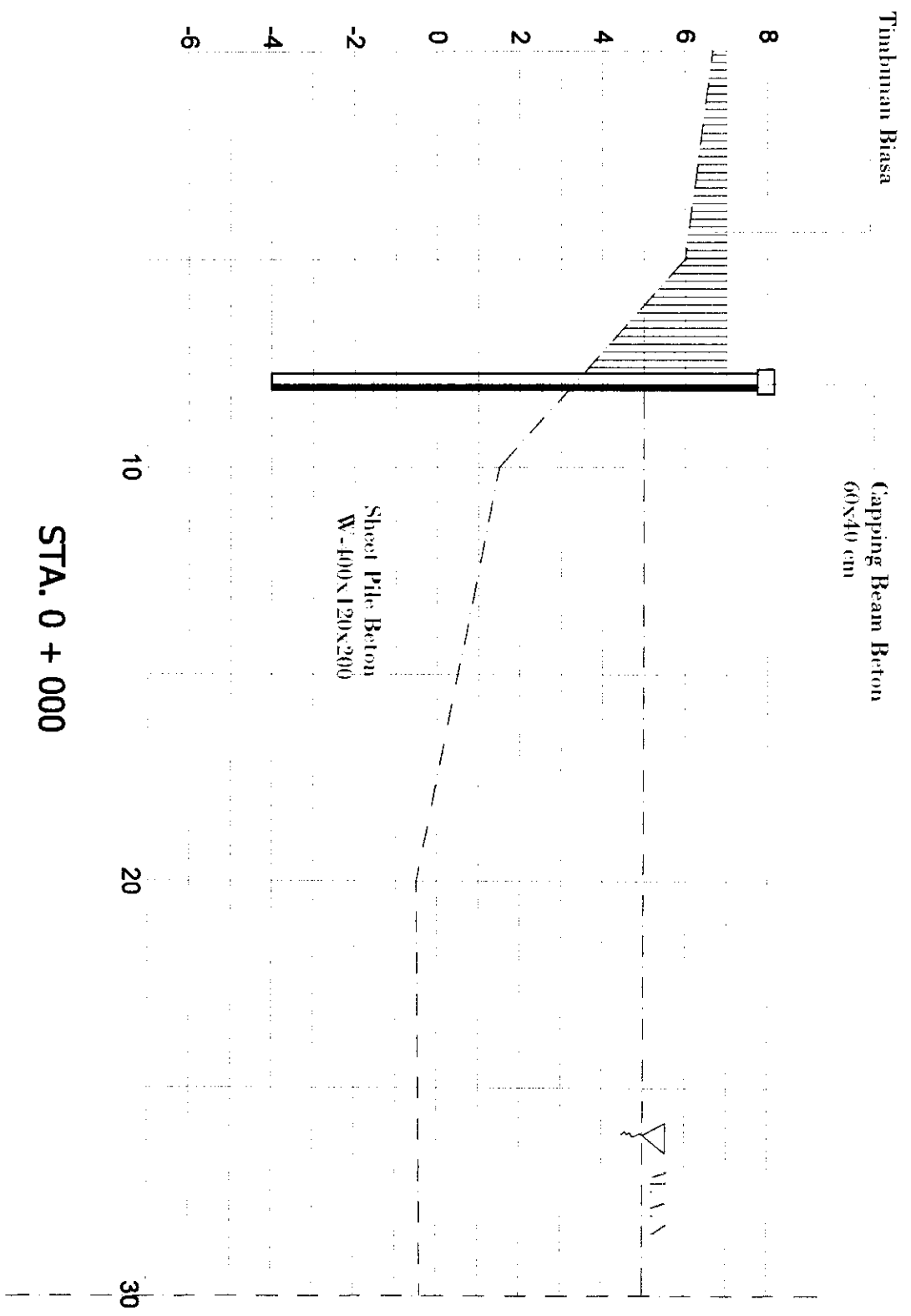

JUDUL GAMBAR		SKALA	
Potongan Melintang		1 : 100	
LEMBAR	05		

Timbunan Biasa

Capping Beam Beton
60x40 cm

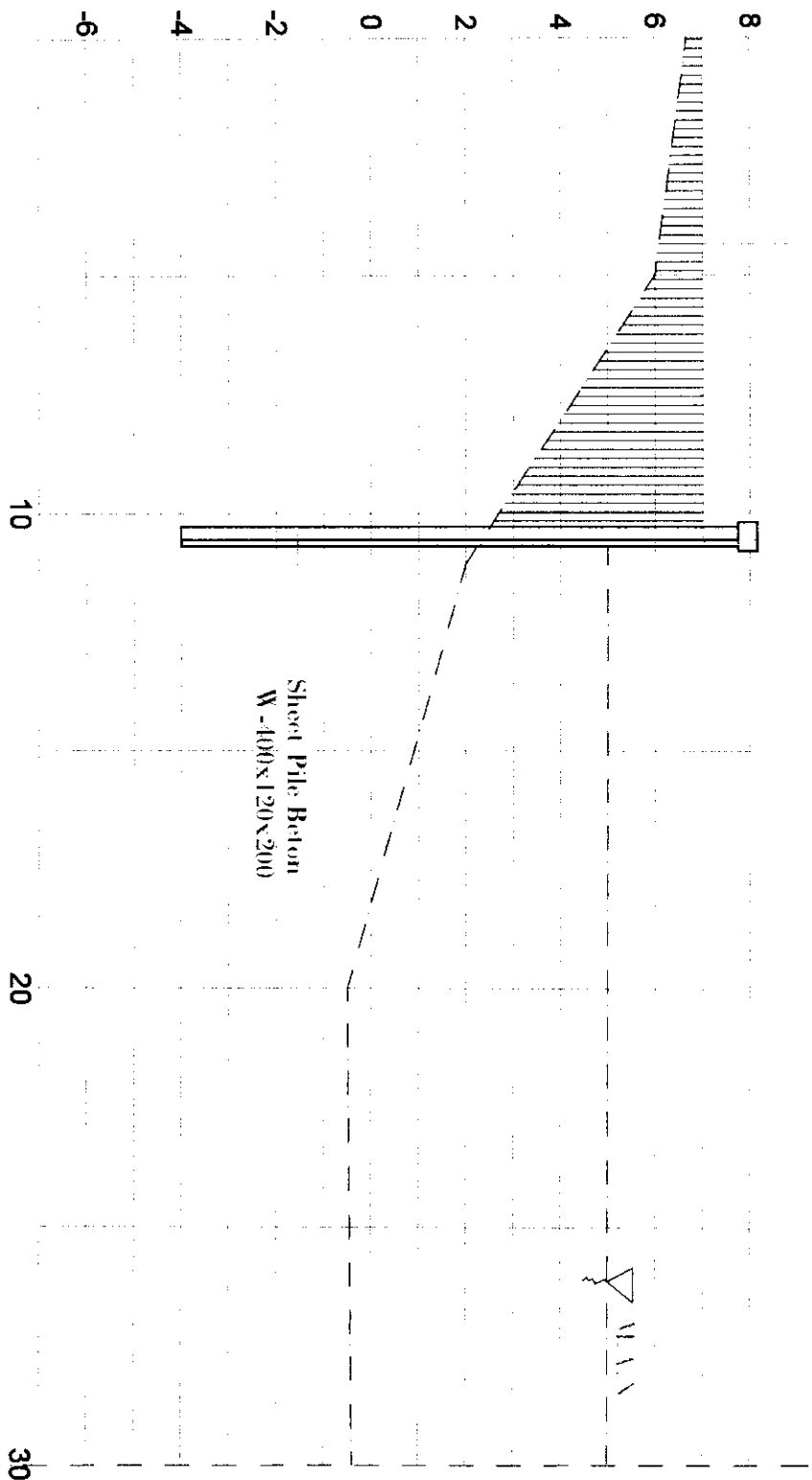

STA. 0 + 050

JUDUL GAMBAR		SKALA	
Potongan Melintang		1 : 100	
LEMBAR	06		

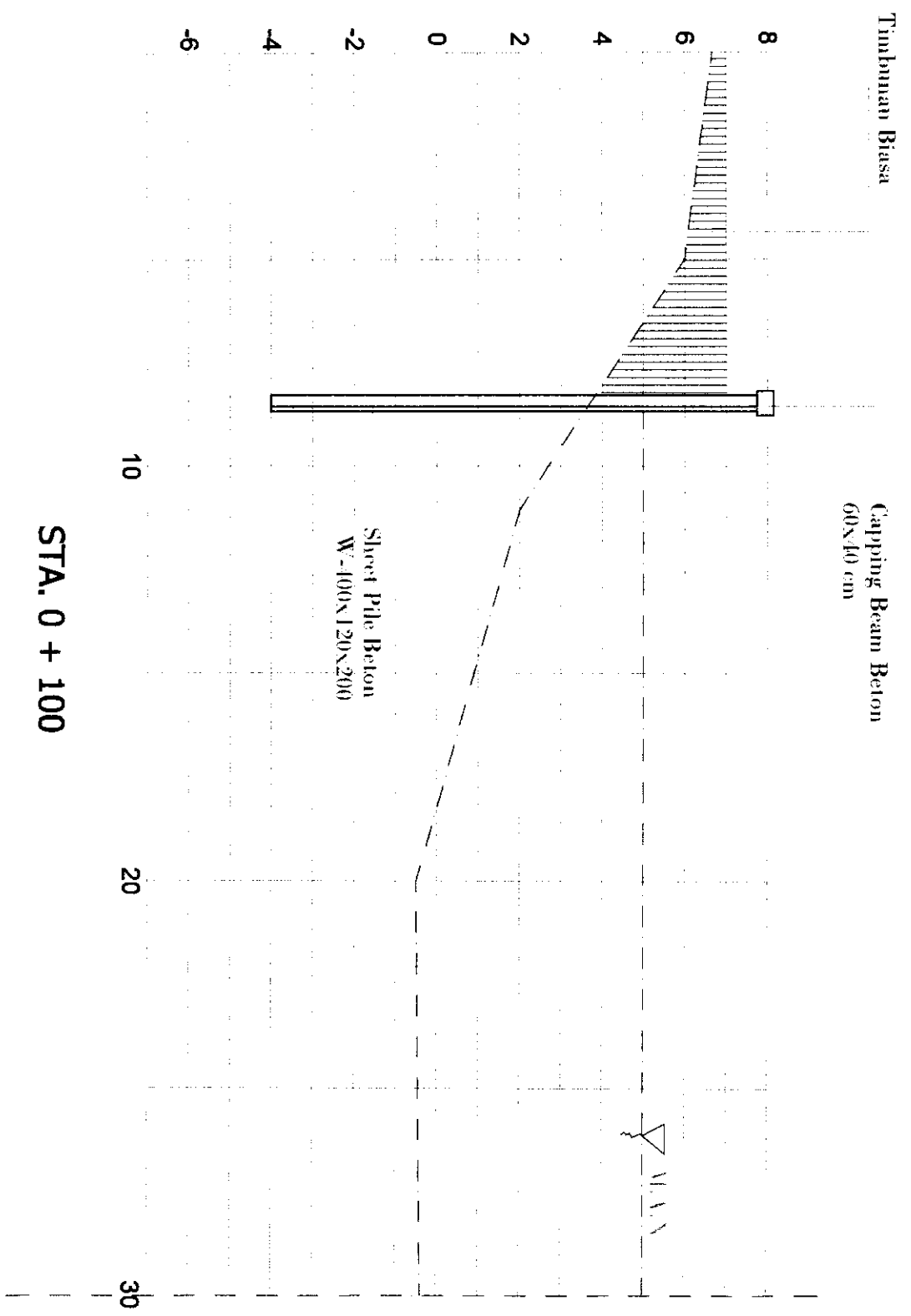

JUDUL GAMBAR		SKALA	
Potongan Melintang		1 : 100	
LEMBAR	07		

Timbunan Biasa

Capping Beam Beton
60x40 cm

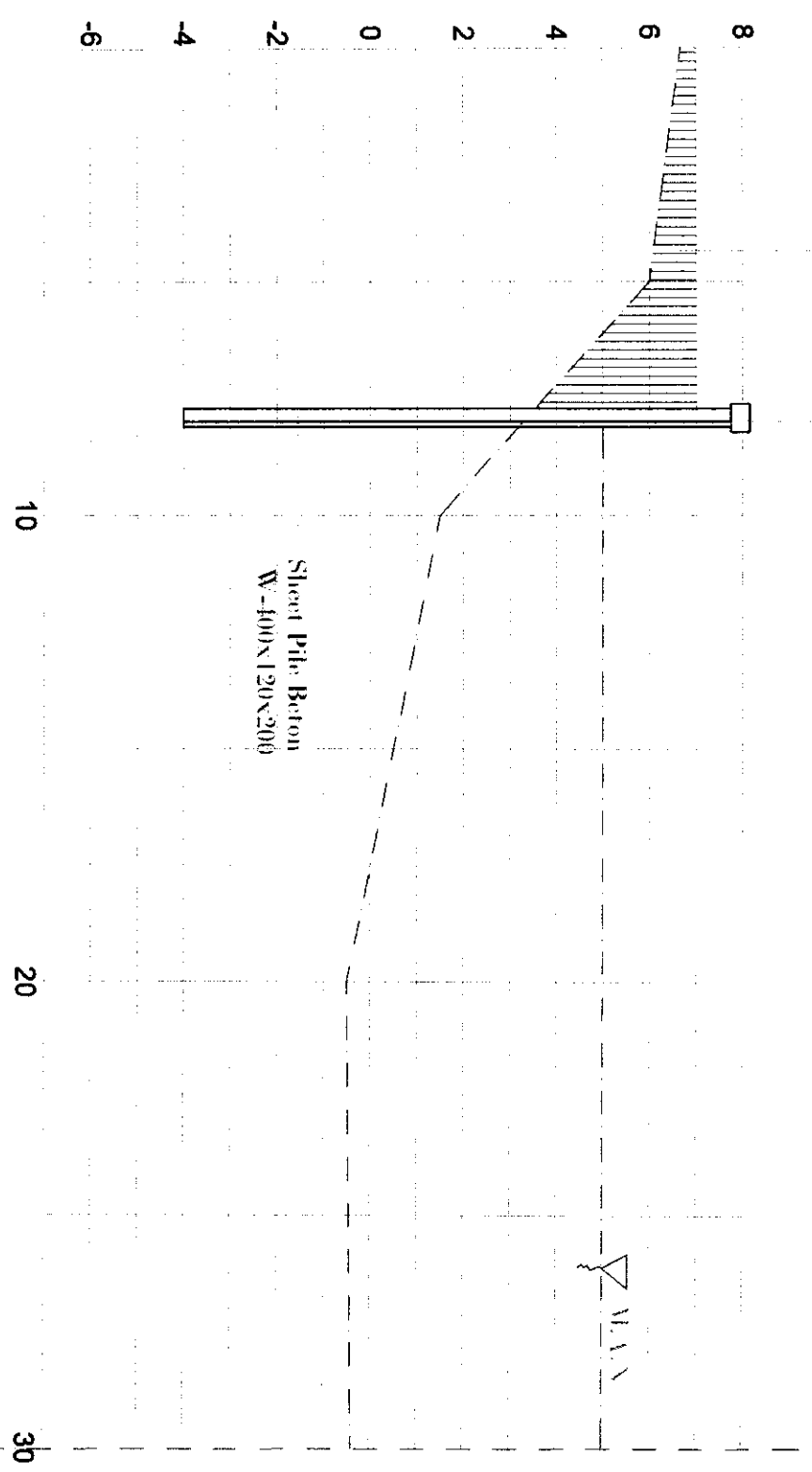

STA. 0 + 150

JUDUL GAMBAR	SKALA
Potongan Melintang	1 : 100
LEMBAR	08

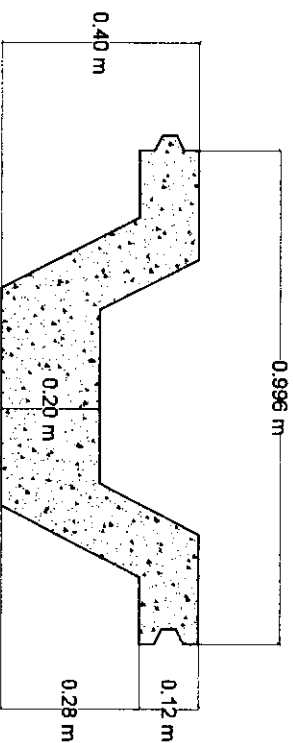
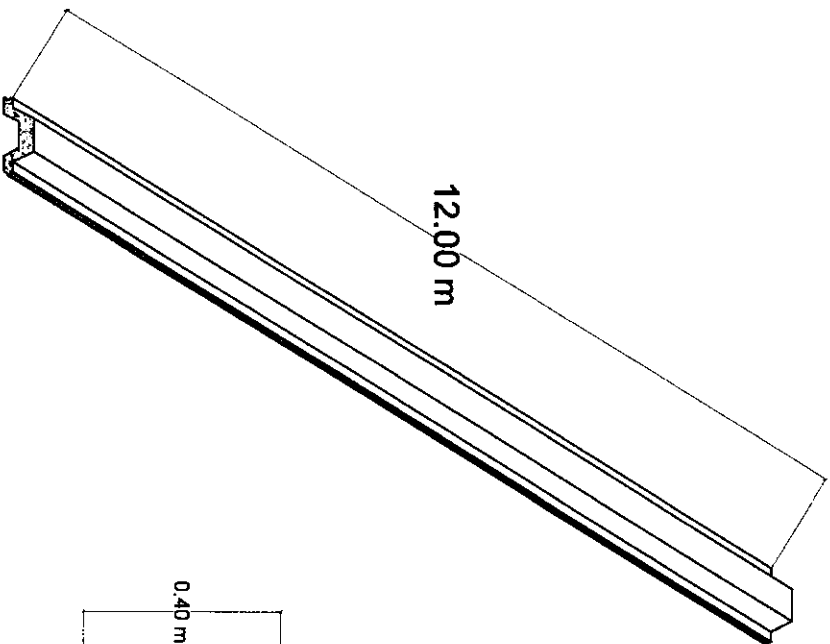
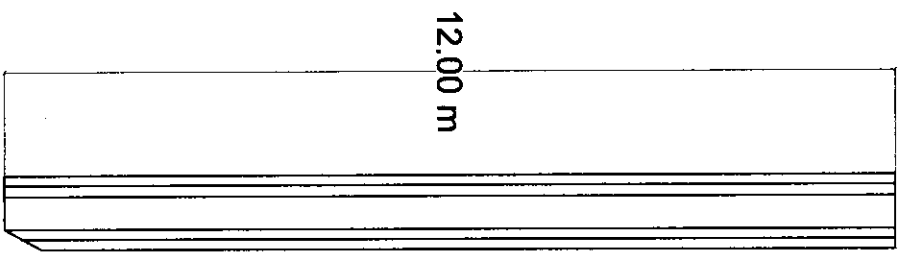

Det. Sheet Pile Beton W-400x120x200
Skala 1 : 10

JUDUL GAMBAR		SKALA	
Detail Sheet Pile Beton		1 : 150	
LEMBAR	09		

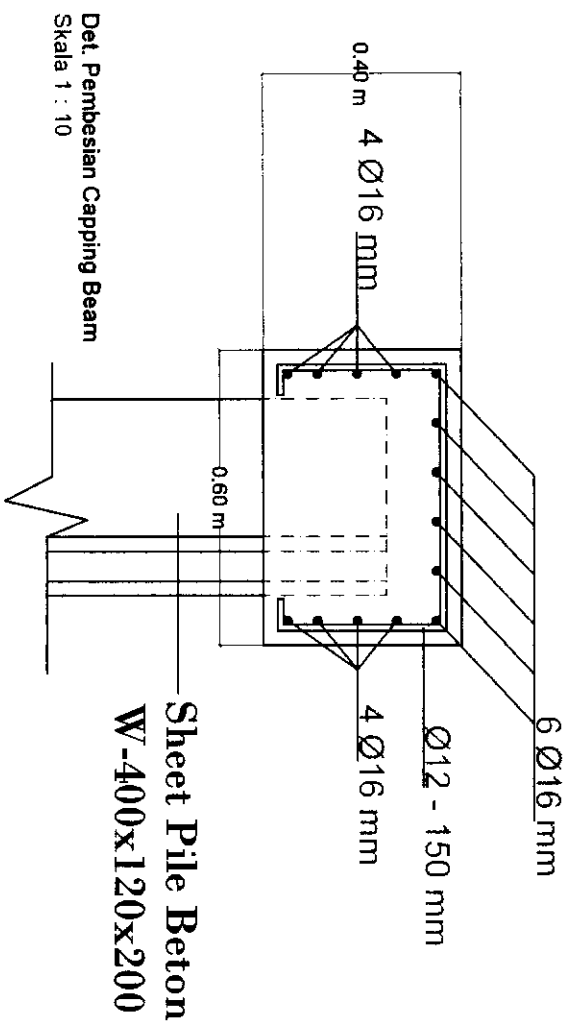
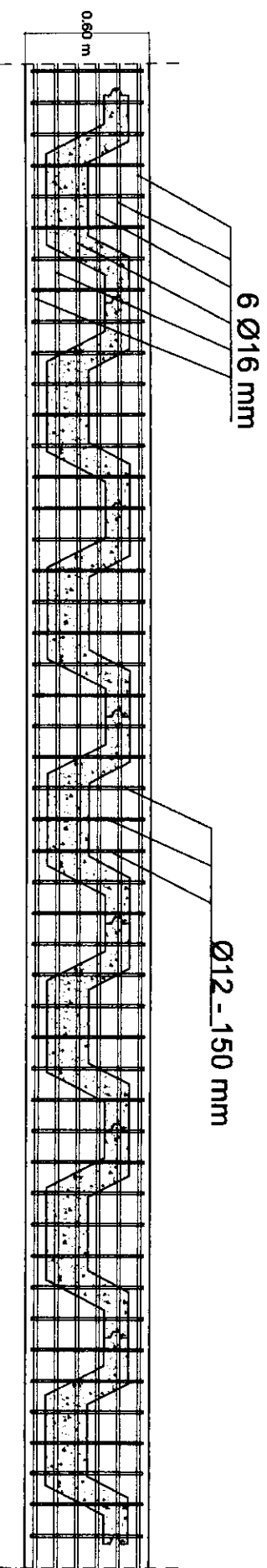
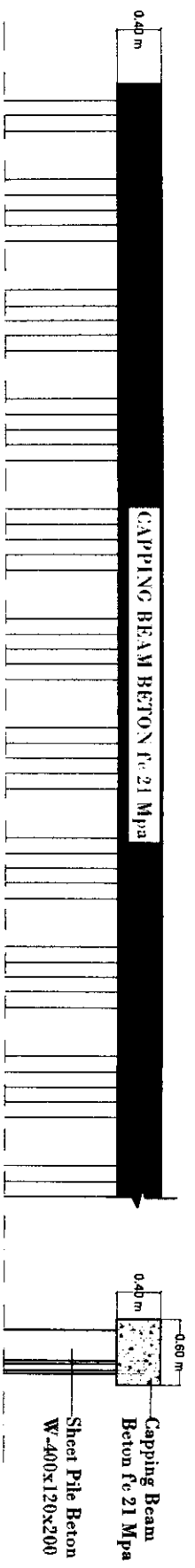

Pembesian Capping Beam
Skala 1 : 20

Sheet Pile Beton
W-400x120x200

Det. Pembesian Capping Beam
Skala 1 : 10

JUDUL GAMBAR	SKALA
Capping Beam + Pembesian	1 : 40
LEMBAR	10

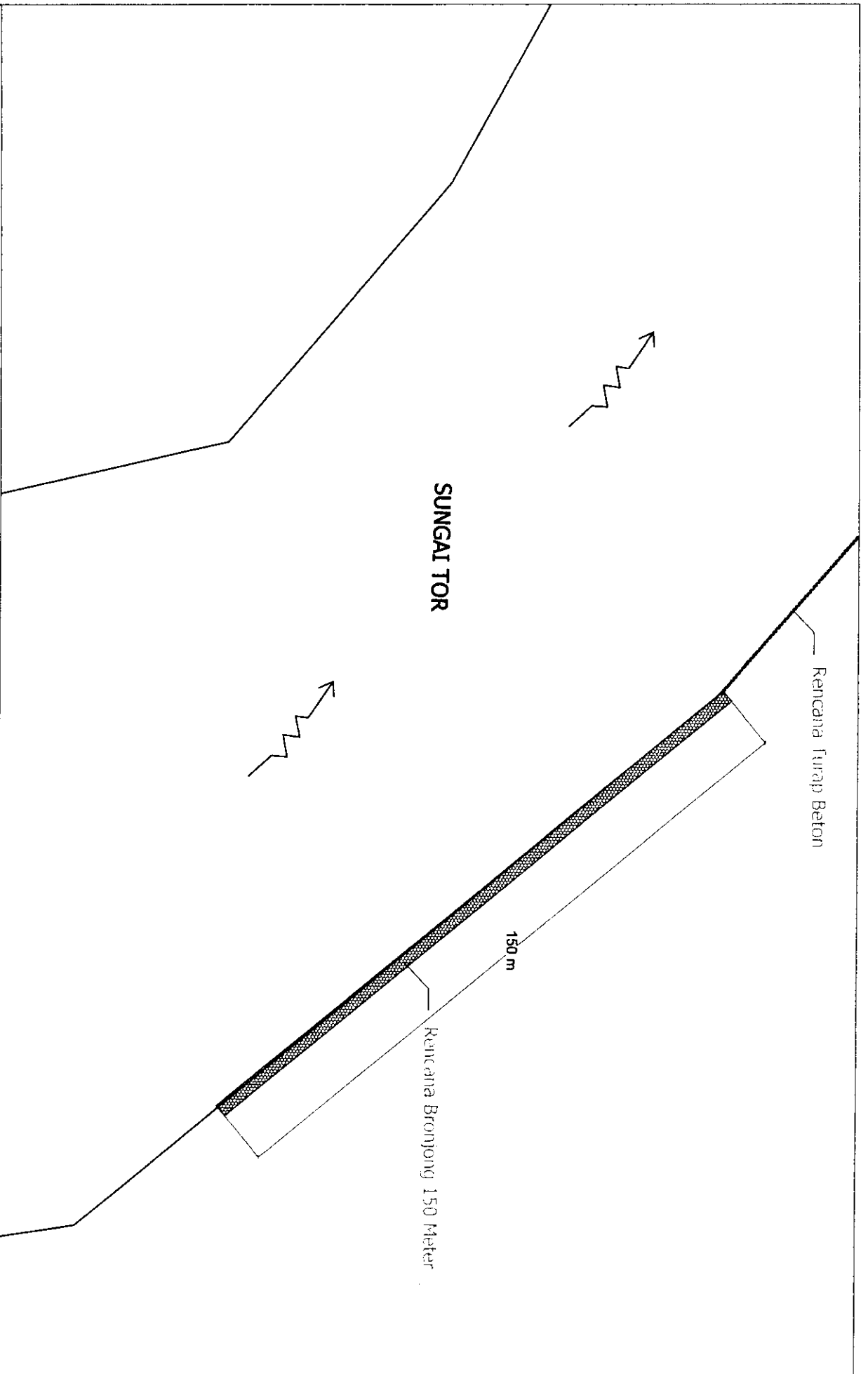

JUDUL GAMBAR Denah Bronjong		SKALA	
		1 : 800	
LEMBAR	11		

Bronjong 2 N 1 x 0.5

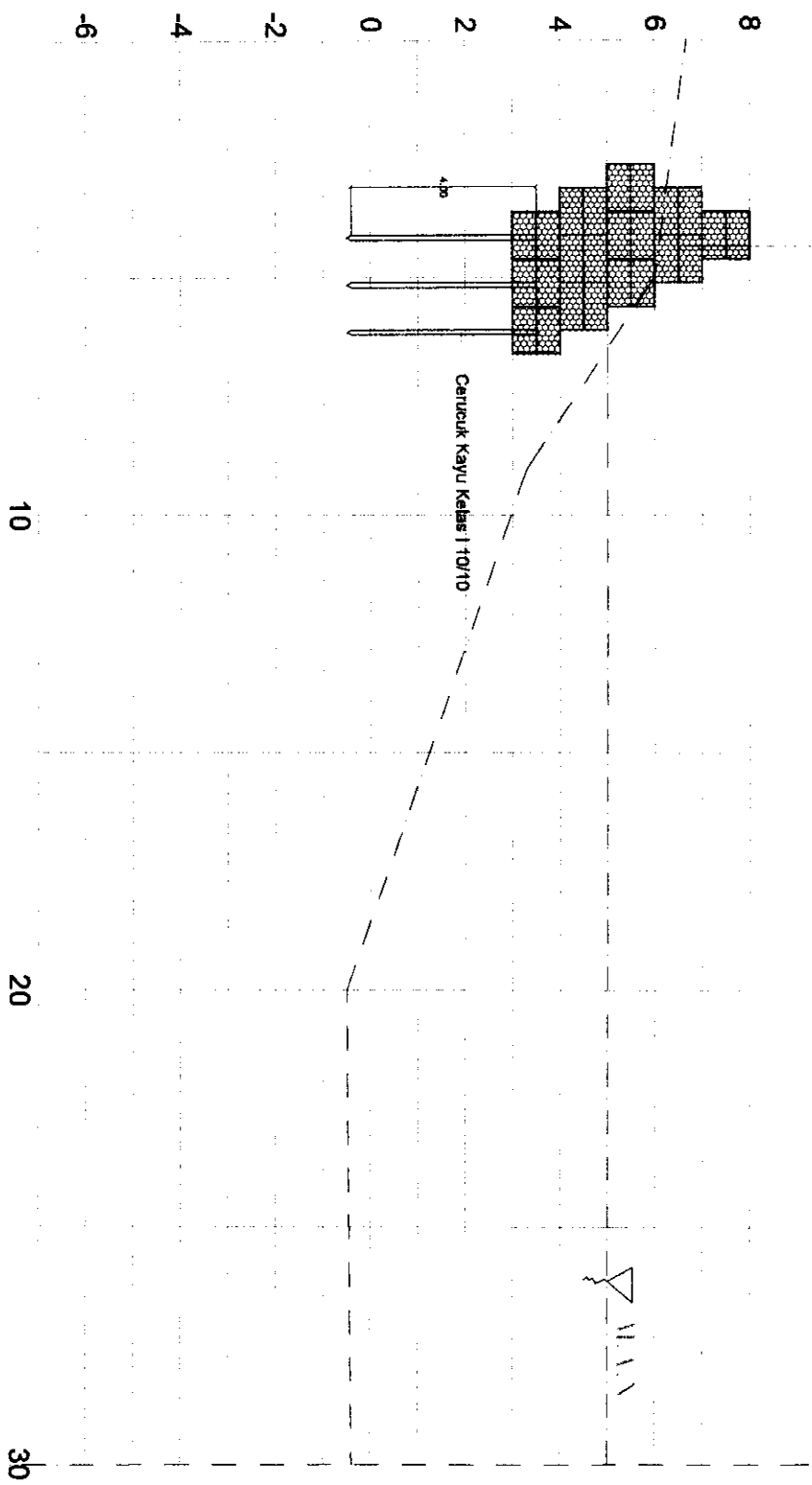

JUDUL GAMBAR		SKALA	
Potongan Melintang		1 : 100	
		LEMBAR	12

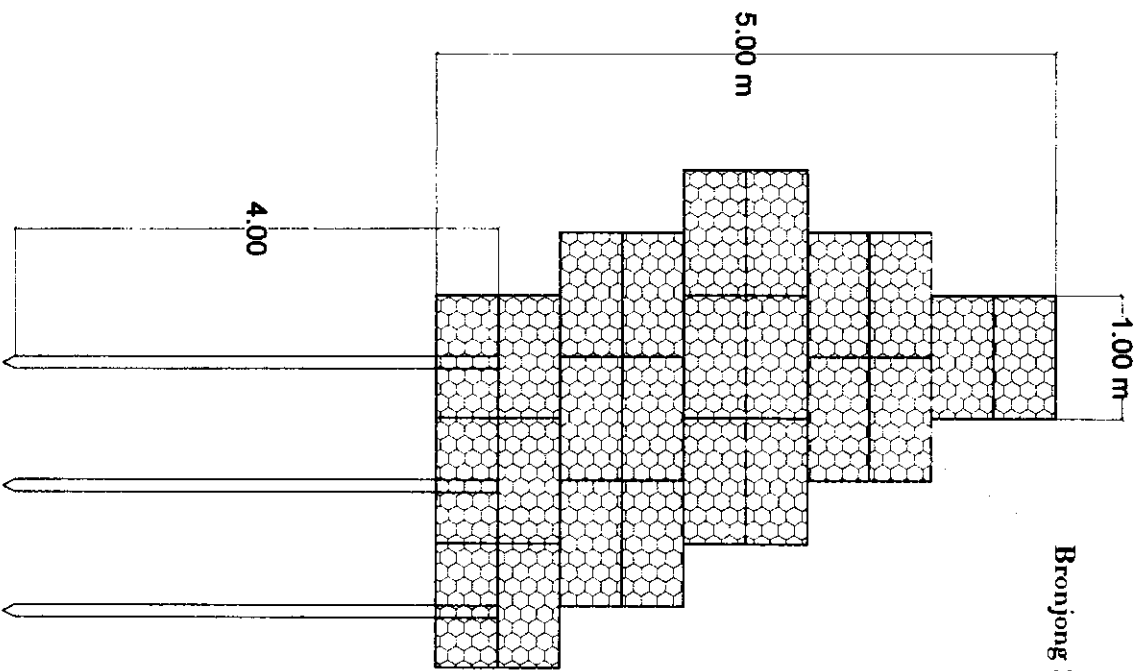

Bronjong 2 x 1 x 0.5

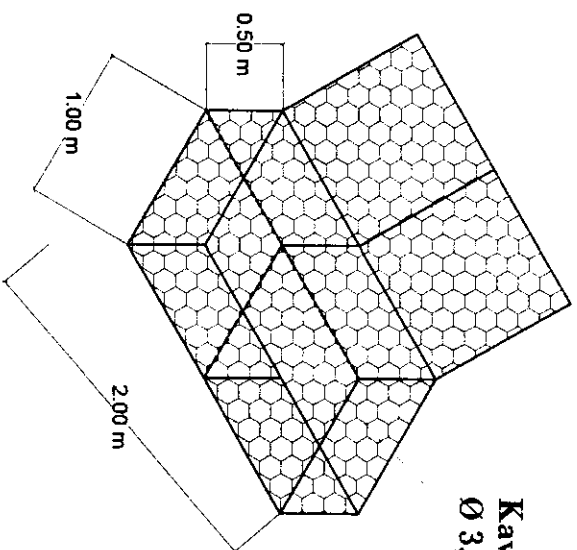

Kawat Bronjong
Ø 3,0 mm

Cerucuk Kayu Kelas I 10/10

JUDUL GAMBAR		SKALA
Detail Bronjong		1 : 40
LEMBAR	13	

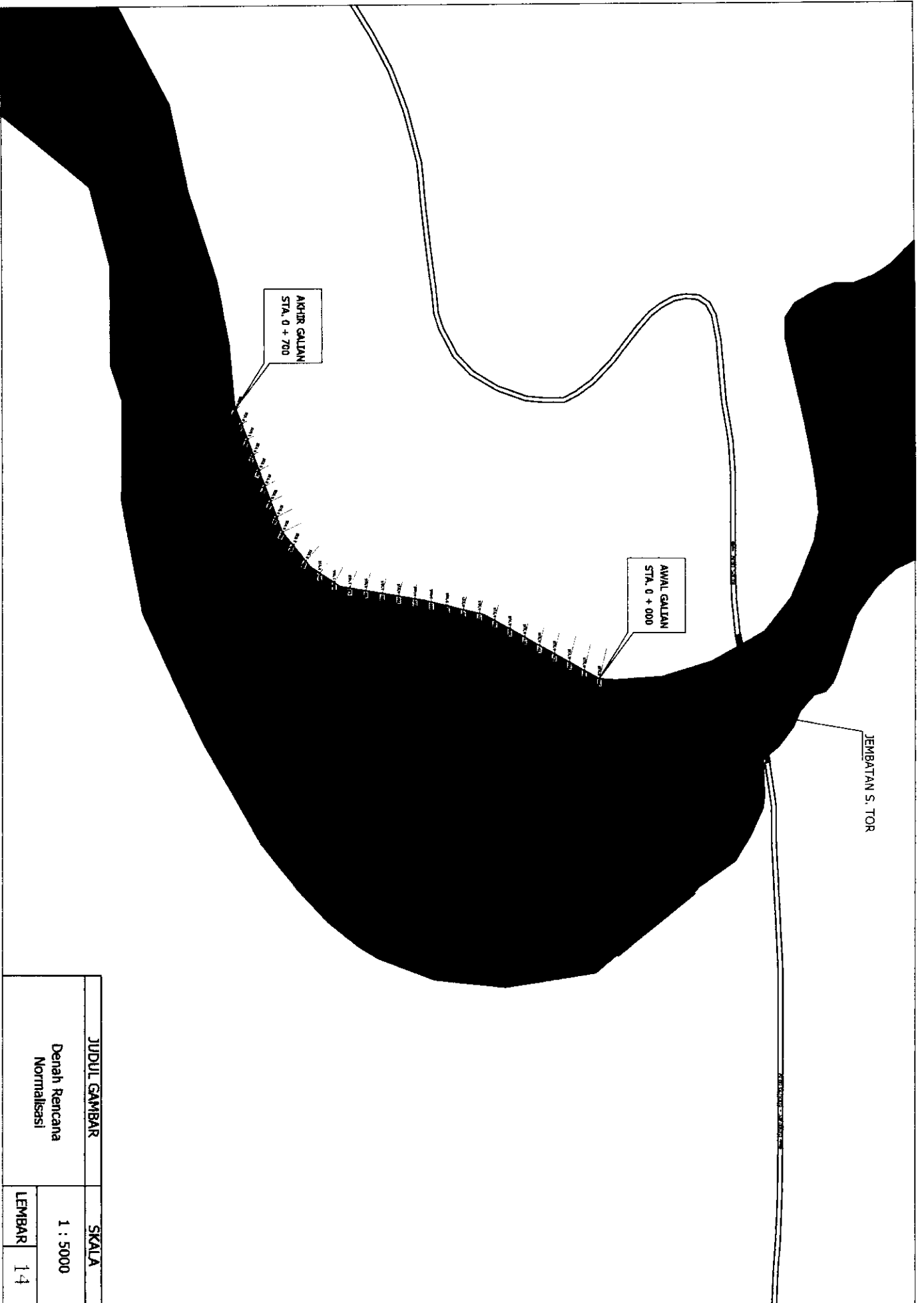

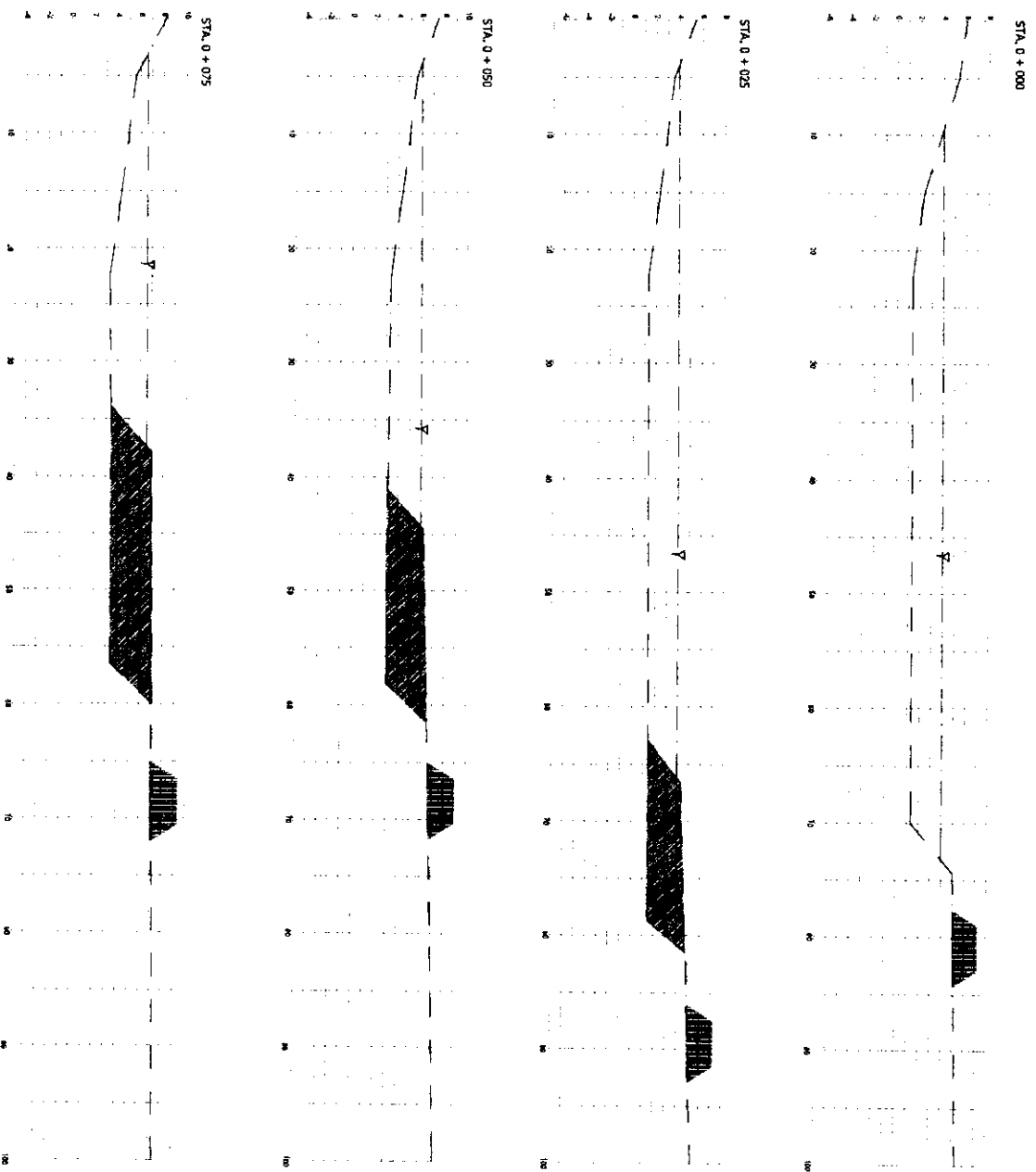

JUDUL GAMBAR		SKALA
Potongan Melintang		1 : 400
LEMBAR	15	

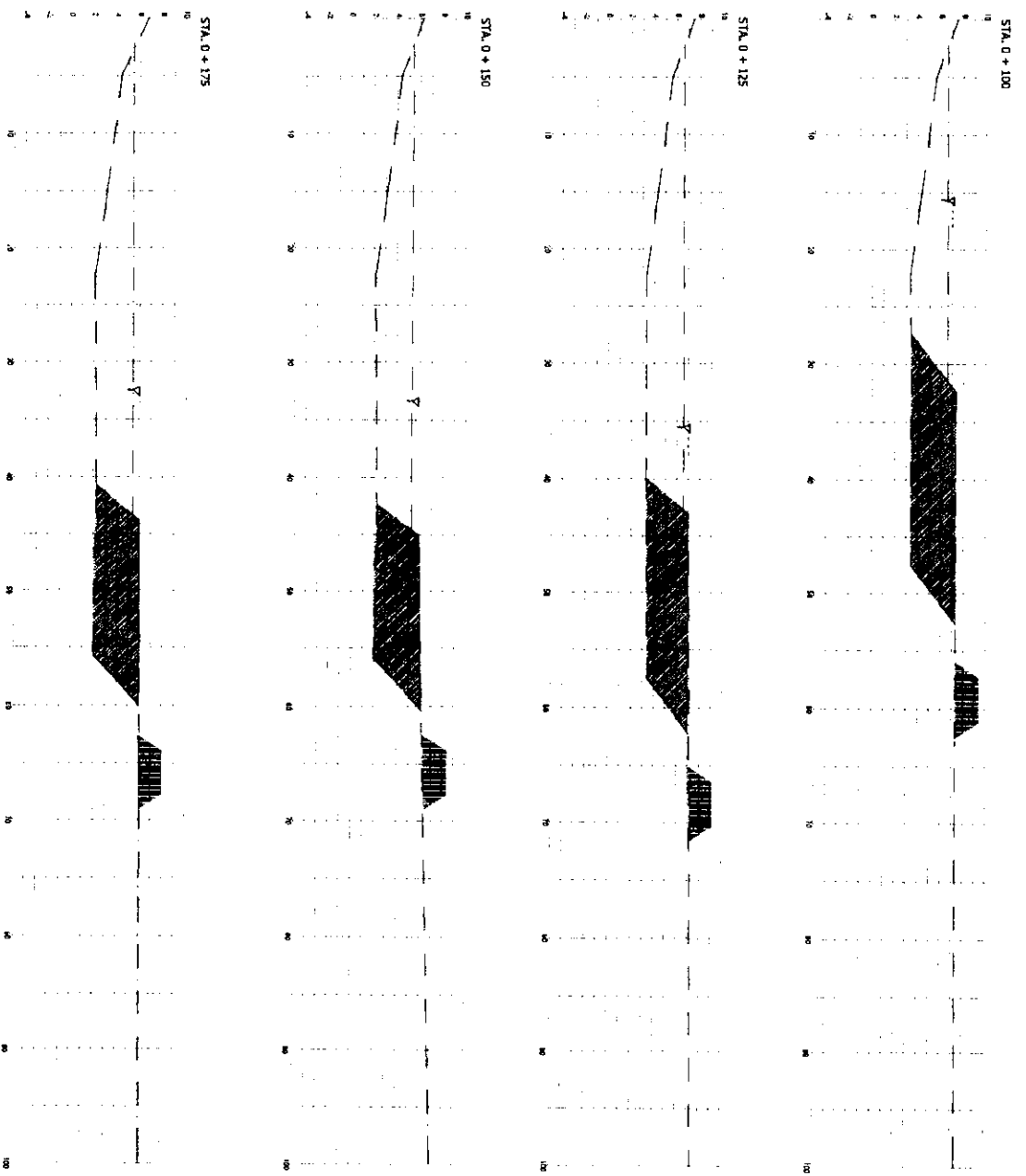

JUDUL GAMBAR		SKALA
Potongan Melintang		1 : 400
LEMBAR	16	

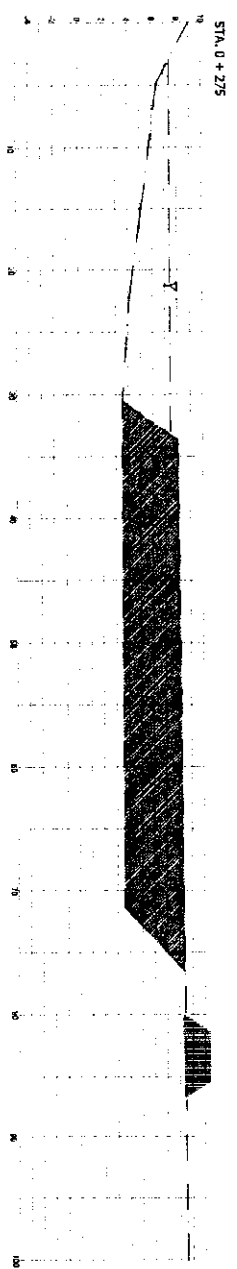
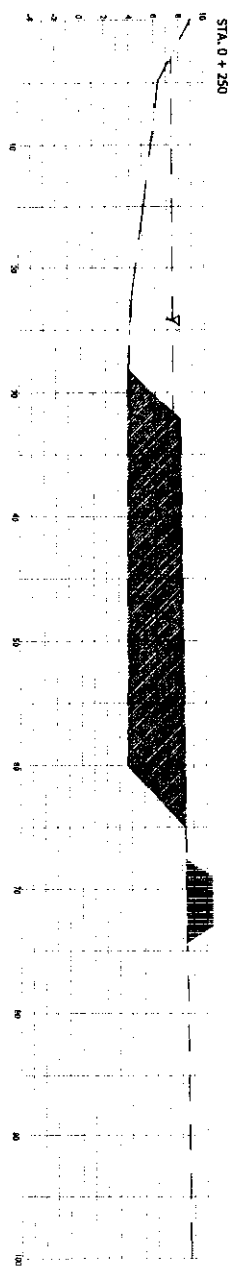
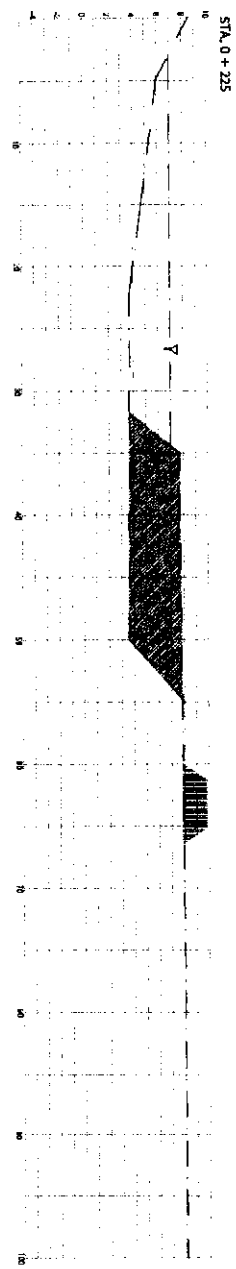
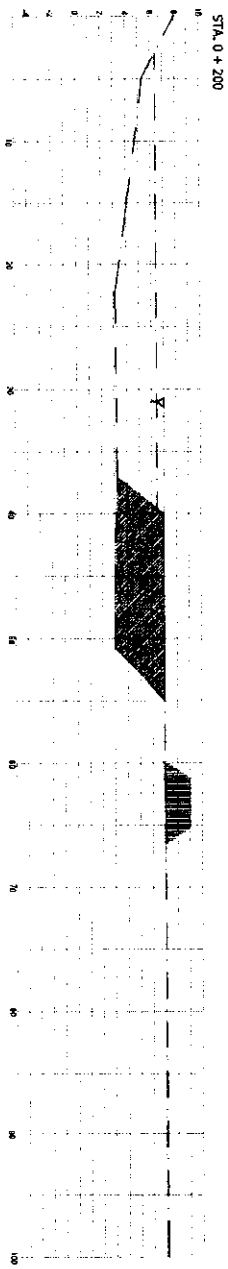

JUDUL GAMBAR		SKALA
Potongan Melintang		1 : 400
LEMBAR	17	

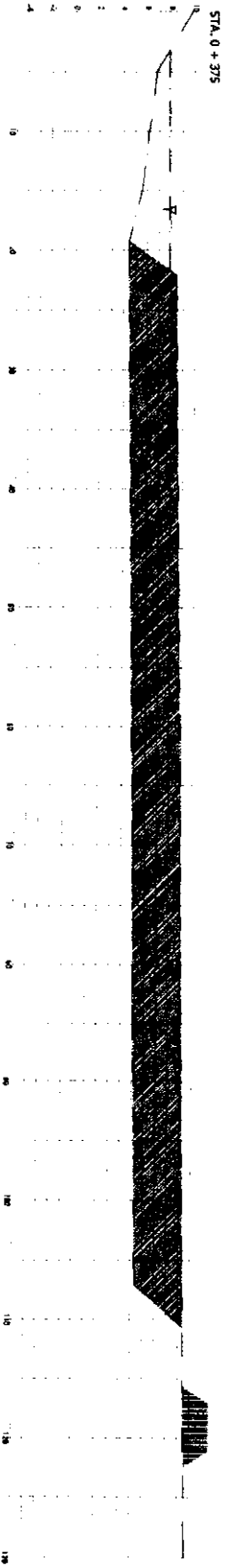
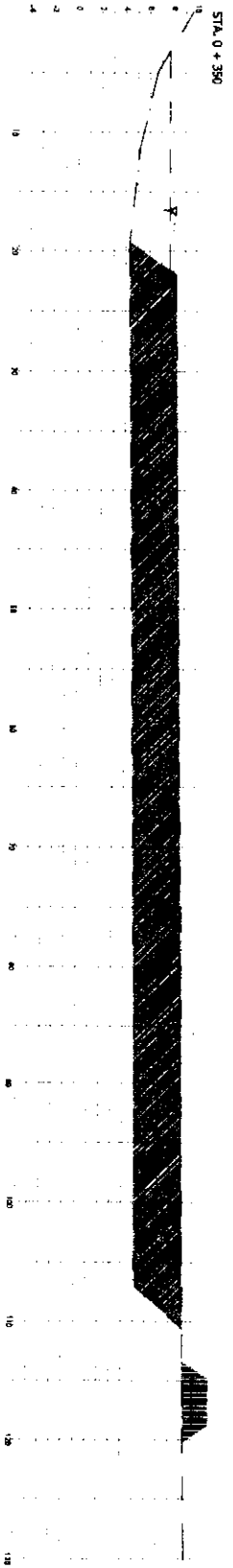
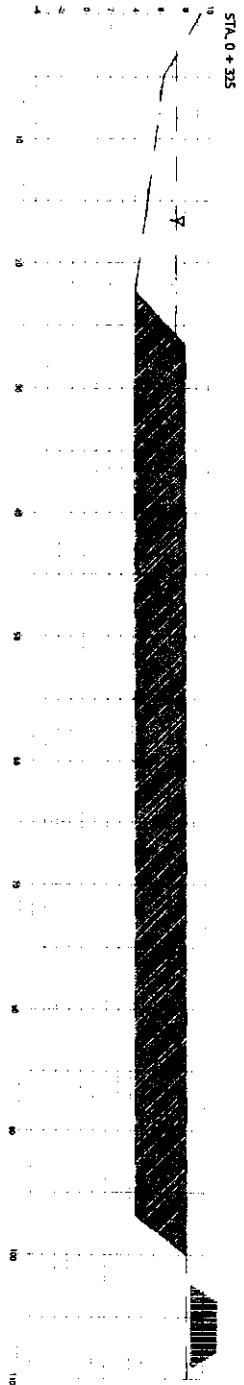
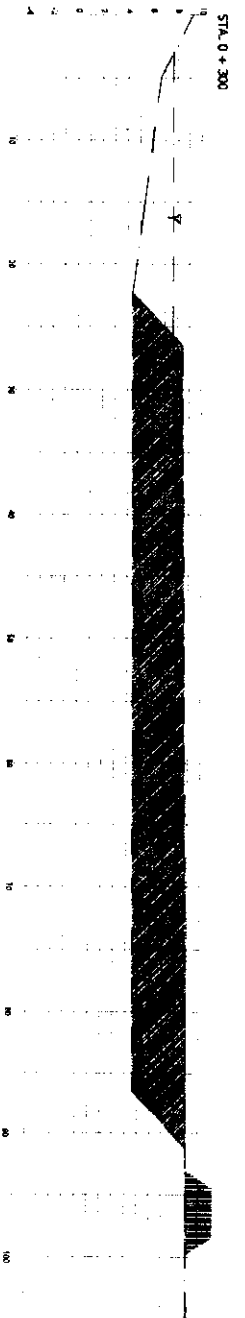

JUDUL GAMBAR		SKALA
Potongan Melintang		1 : 400
LEMBAR	18	

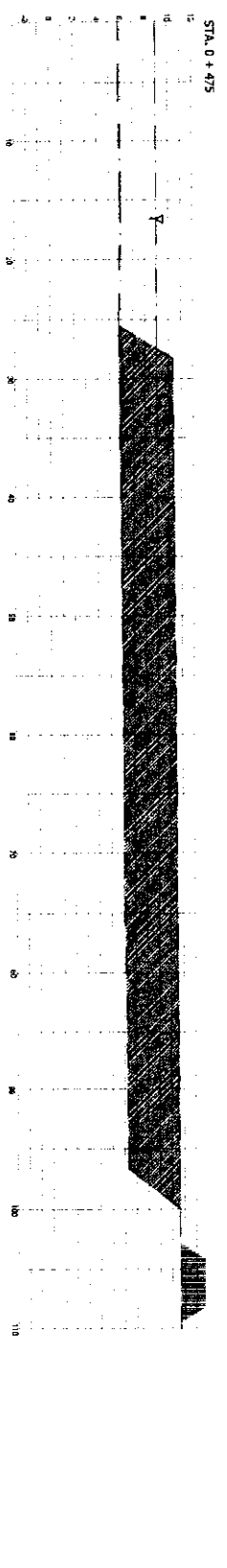
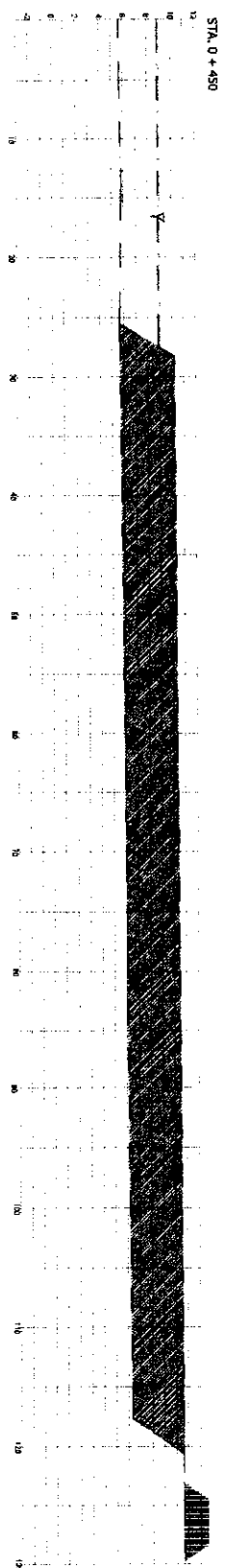
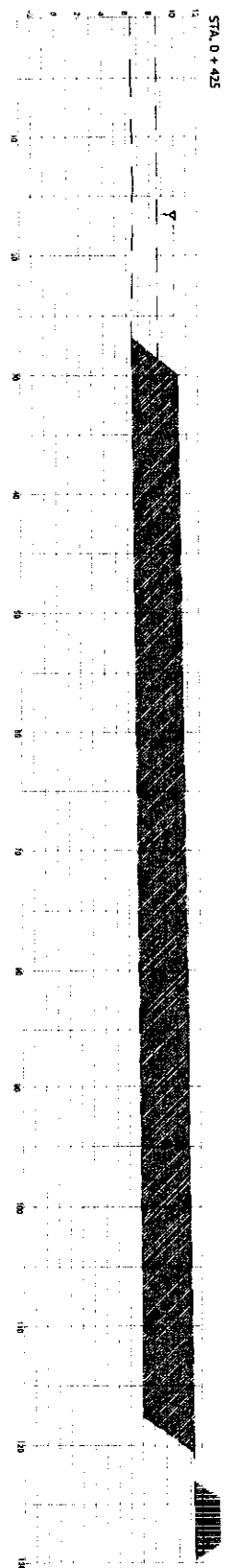
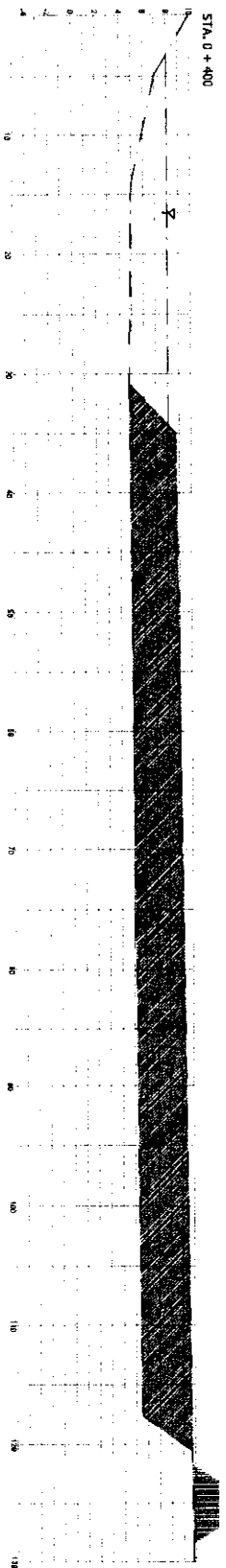

JUDUL GAMBAR		SKALA
Potongan Melintang		1 : 400
LEMBAR	19	

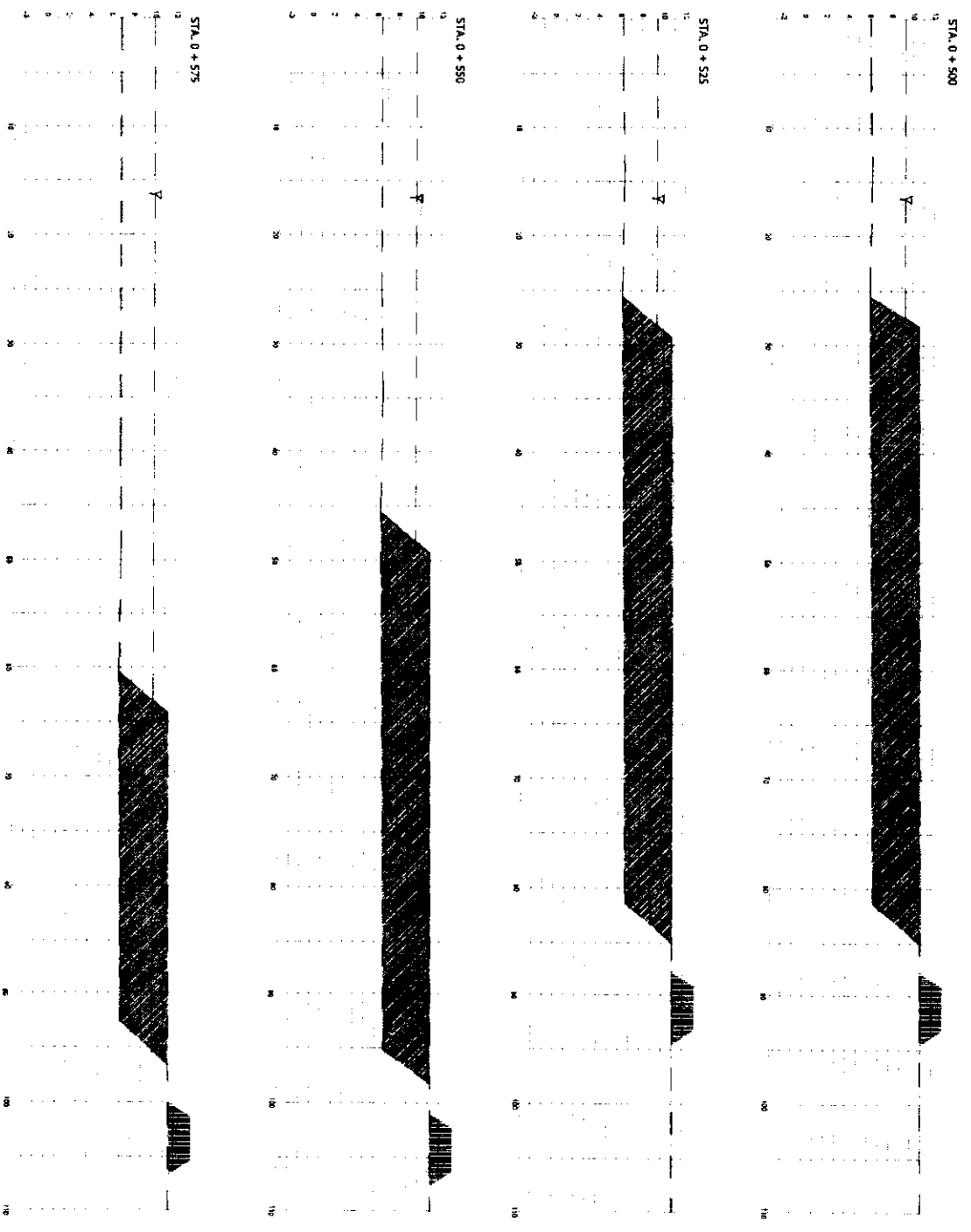

JUDUL GAMBAR		SKALA
Potongan Melintang		1 : 400
LEMBAR	20	

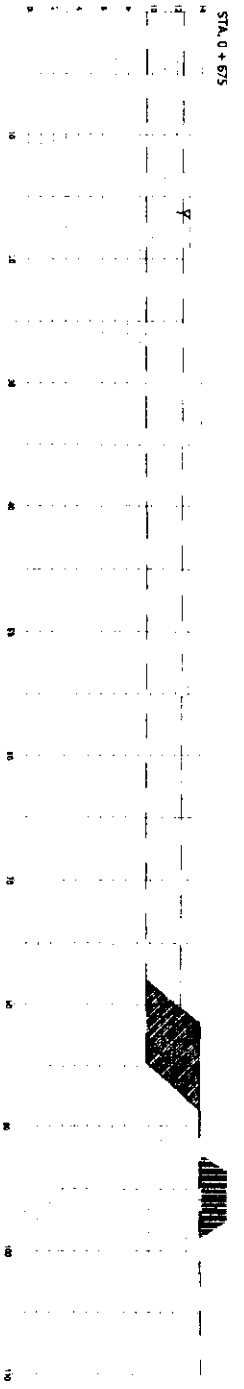
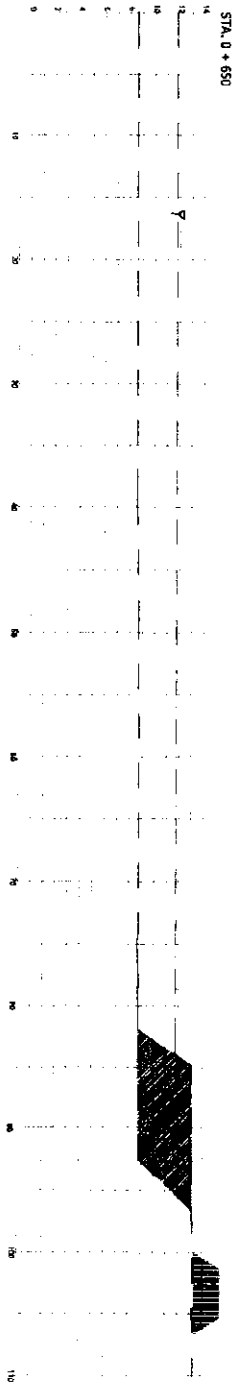
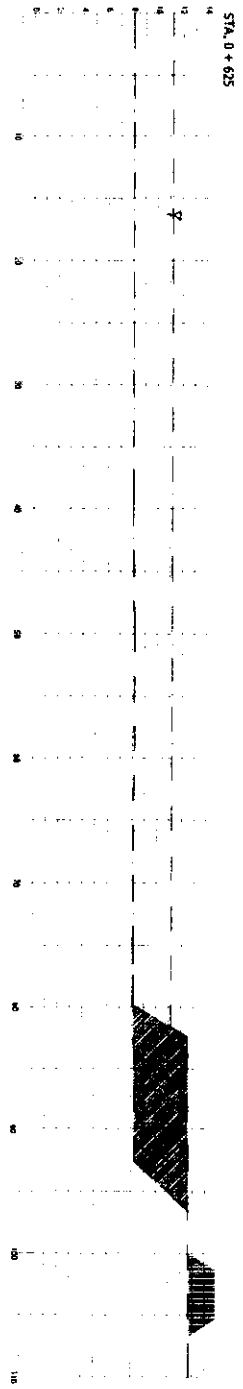
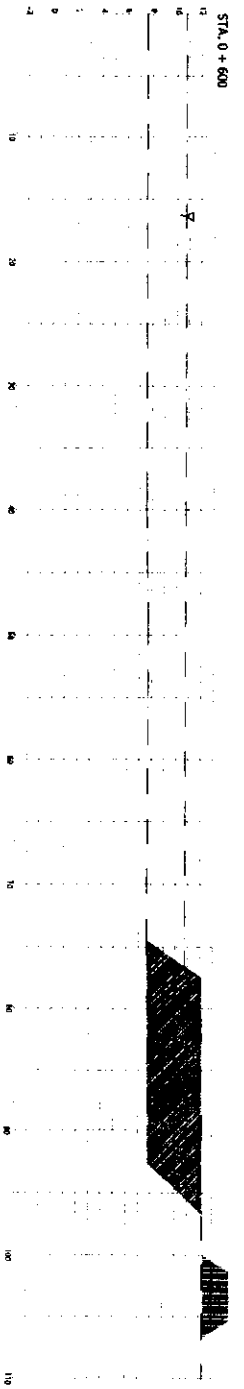

JUDUL GAMBAR		SKALA
Potongan Melintang		1 : 400
LEMBAR	21	

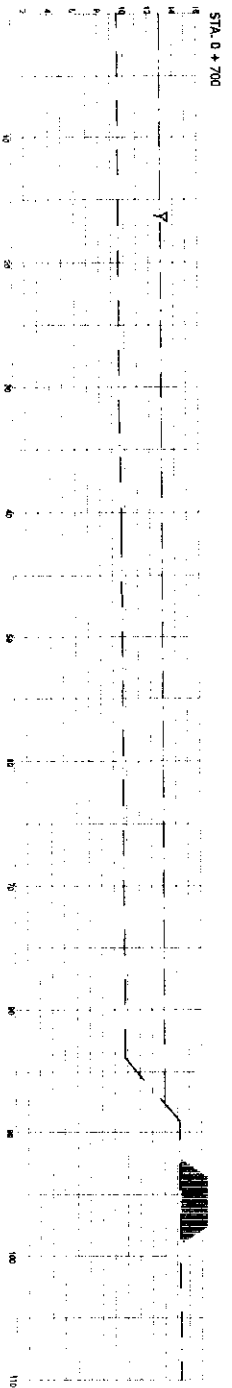

JUDUL GAMBAR		SKALA	
Potongan Melintang		1 : 400	
LEMBAR	22		